

Монтажная инструкция DORMA Agile 150 с боковой панелью

Installation instruction DORMA Agile 150 Sidelight inlaid profile

Содержание: Index of contents:

S. 2	Обзор профилей Profile overview
S. 2-4	Вариант 1: <i>1 раздвижная дверь 1 боковая панель</i> Version1: <i>1 sliding door with 1 sidelight</i>
S. 4-6	Вариант 2: <i>1 раздвижная дверь 2 боковых панелей</i> Version 2: <i>1 sliding door with 2 sidelights</i>
S. 6-8	Вариант 3: <i>2 раздвижных дверей 2 боковых панелей</i> Version 3: <i>2 sliding doors with 2 sidelights</i>
S.9-10	Установка профиля для бокового экрана с заглушкой Installation of sidelight inlaid profile

Обзор профилей:
Profile content:

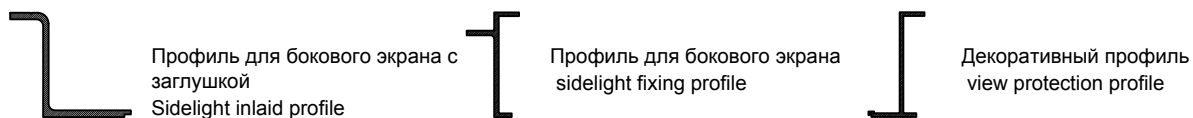

Вариант 1:
Version 1:

Sicht von unten
View from below

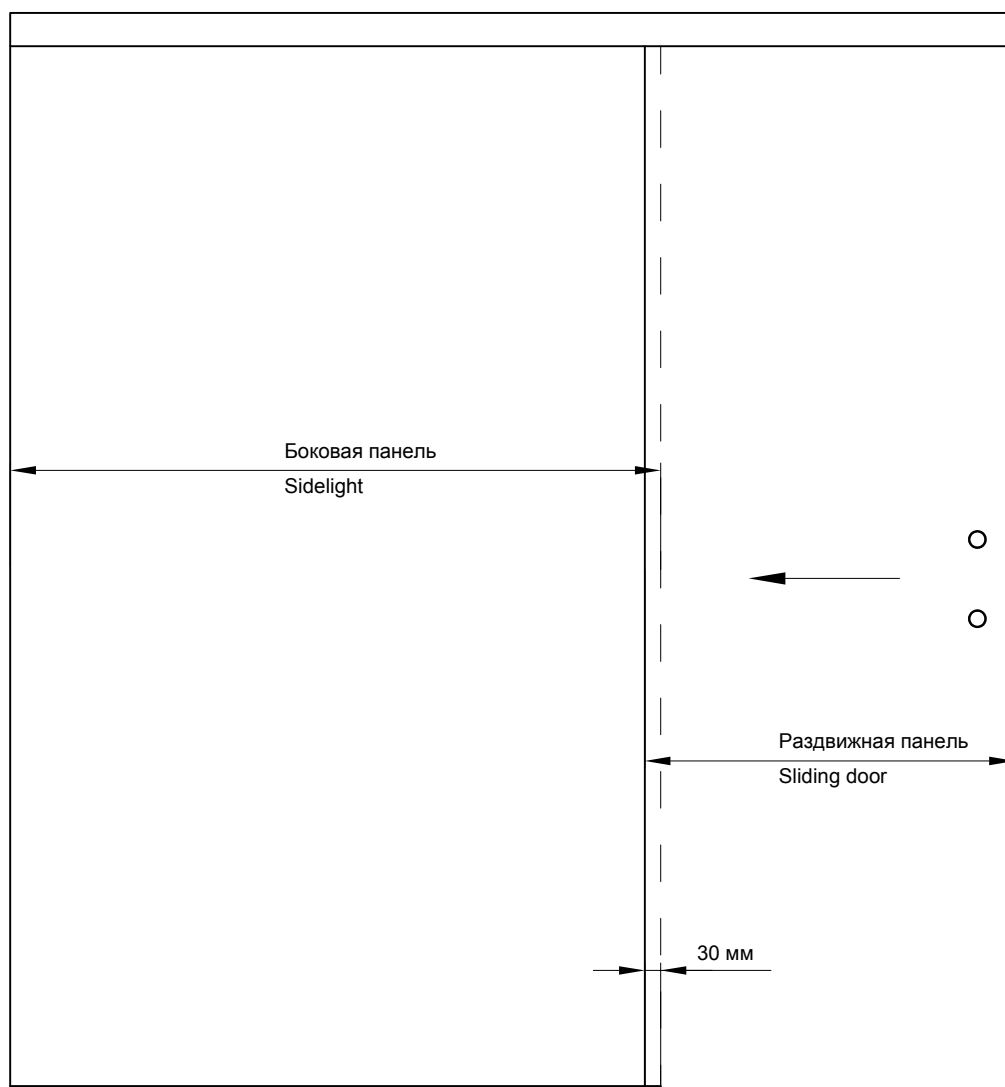
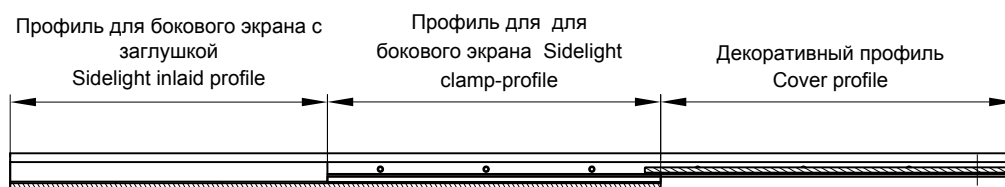

Вариант 1:
Version 1:

1. Нарезка профилей:
1. Cutting of profiles:

Для профилей складской длины:
For stock length profiles:

Das Profil wird unbearbeitet geliefert! Bearbeitung vor Ort notwendig!
Basic raw material is delivered! Workings on site necessary!

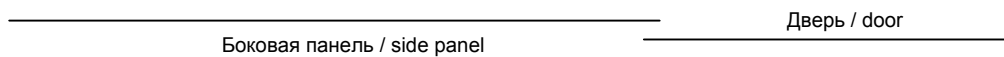

1.1 Sichtschutzprofil auf die benötigte Länge schneiden!
1.1 Cut the view protection profile to the required length!



1.1 Вид снизу:
View from below

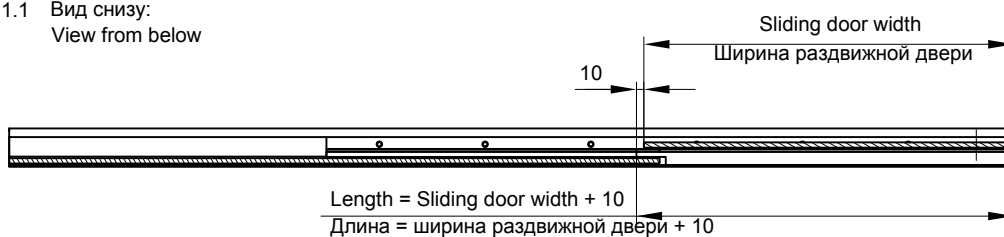

1.1 Das Profil muss zum Seitenteil Konterprofil hin ausgeklinkt werden!
1.1 The profile must be notched on the sidelight clamp profile side!

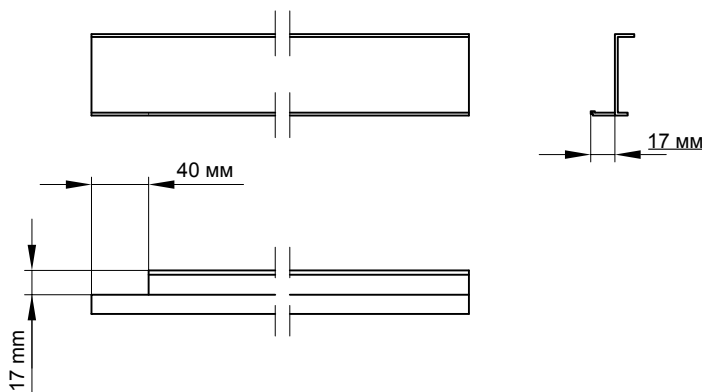

Для заказных профилей:
For customized profiles:

Das Profil wird bearbeitet geliefert! Trotzdem ist ein Bearbeitung vor Ort notwendig!
The profile is costumized delivered! Although workings on site necessary!

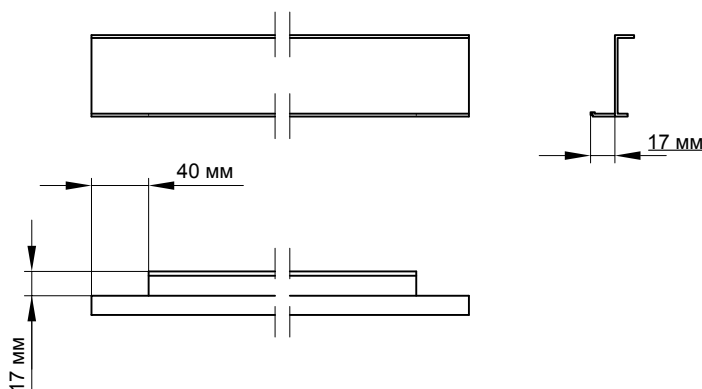

Вариант 1:
Version 1:

Для заказных профилей:
For customized profiles:

1.1 Je nach benötigter Ausführung der Ausklinkung (Rechts/Links), Profil einseitig auf die benötigte Länge schneiden!
1.1 According to required application of notch (RH/LH), cut the profile onesided to required length!

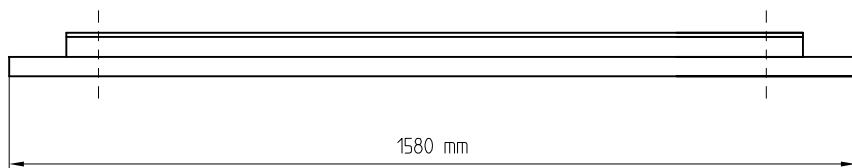

1.2 Seitenteil-Konterprofil auf die benötigte Länge schneiden!
1.2 Conform the sidelight clamp-profile to the desired length!

1.2 Вид снизу:
View from below

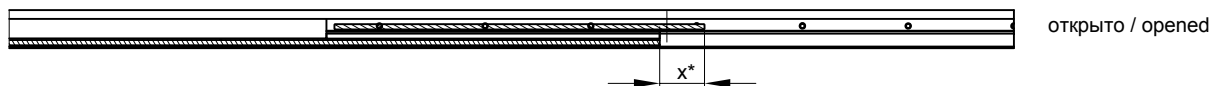
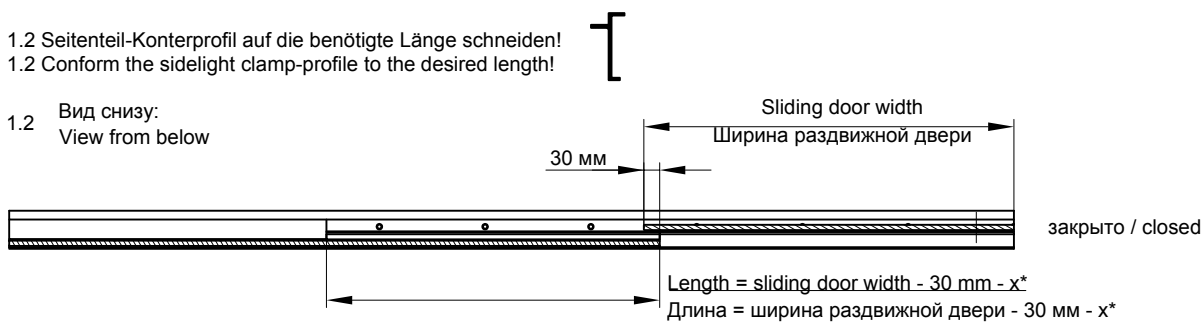

* X ergibt sich aus der Art und Position des Griffes.
* X is a result of form and position of the pull handle.

1.3 Seitenteil-Einlegeprofil auf die benötigte Länge schneiden!
1.3 Conform the sidelight inlaid profile to the desired length!

1.3 Вид снизу:
View from below

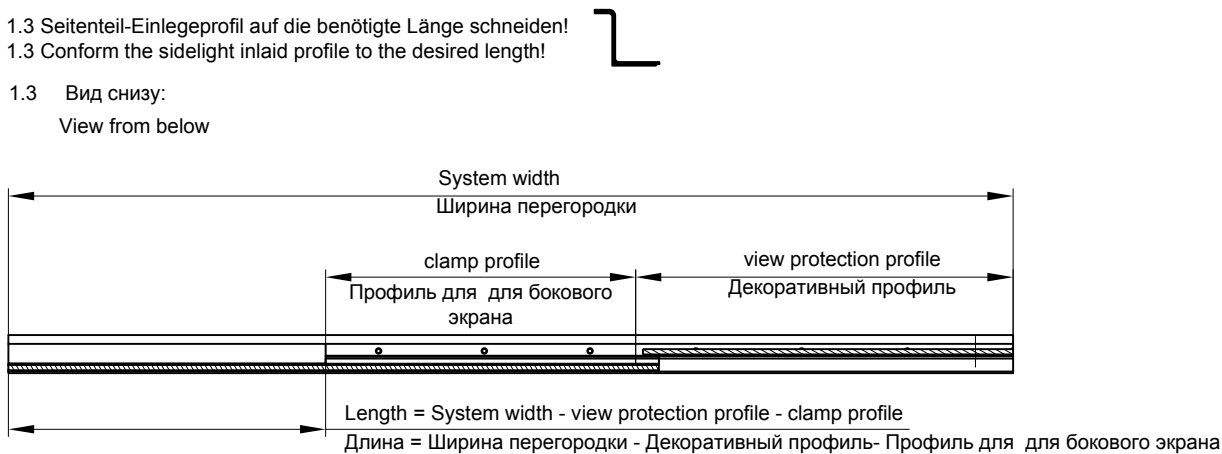

Вариант 2:
Version 2:

2.3 Seitenteil-Einlegeprofil auf die benötigte Länge schneiden!
2.3 Conform the sidelight inlaid profile to the desired length!



2.3 Вид снизу:

View from below

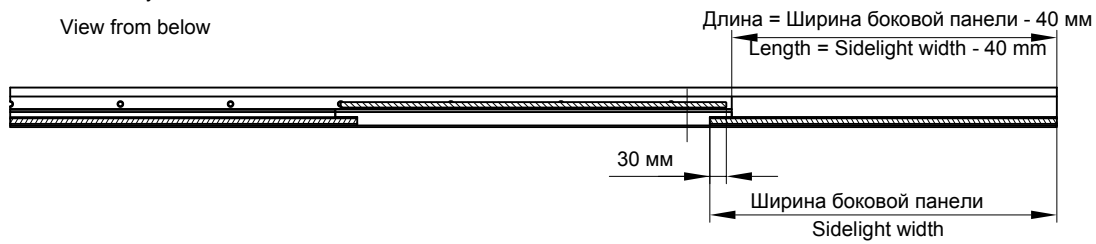

Вариант 3:
Version 3:

Вид снизу:

View from below

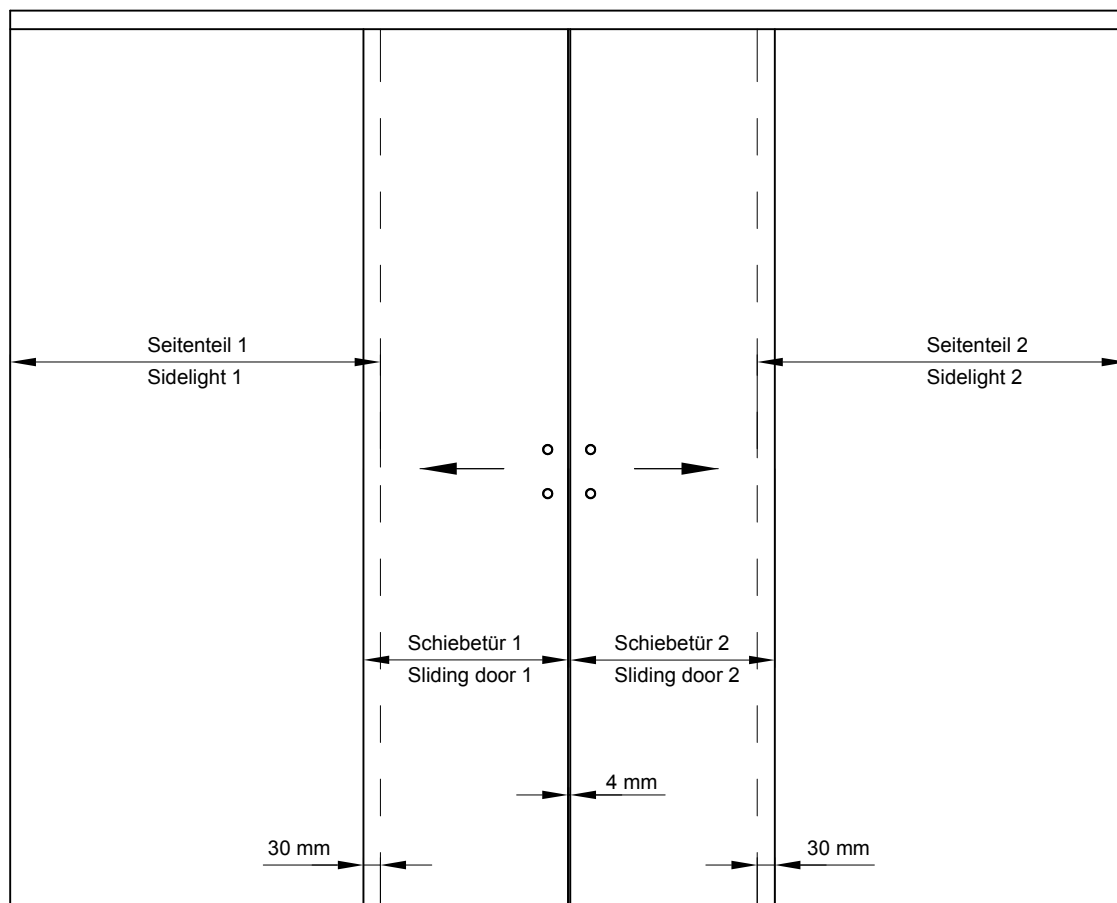

Variante 3:

Version 3:

3. Zuschneiden der Profile:

3. Cutting of profiles:



Für Fix- und Lagerlängen! Bearbeitung vor Ort notwendig!
For customized and stock length profiles! Workings on site necessary!

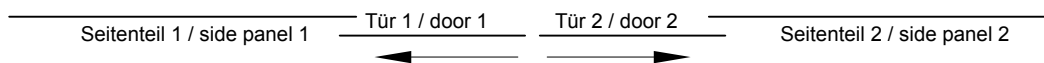

3.1 Sichtschutzprofil auf die benötigte Länge schneiden!
3.1 Conform the view protection profile to the desired length!



3.1 Sicht von unten
View from below

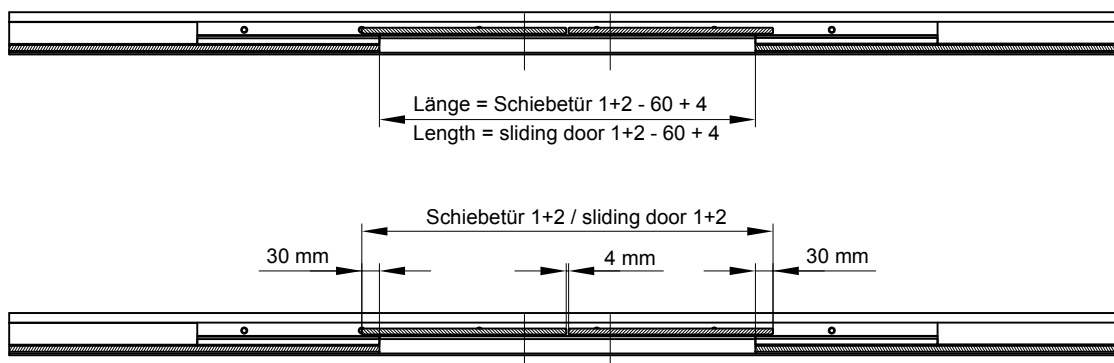

3.2 Seitenteil-Konterprofil auf die benötigte Länge schneiden!
3.2 Conform the sidelight clamp-profile to the desired length!



3.2 Sicht von unten
View from below

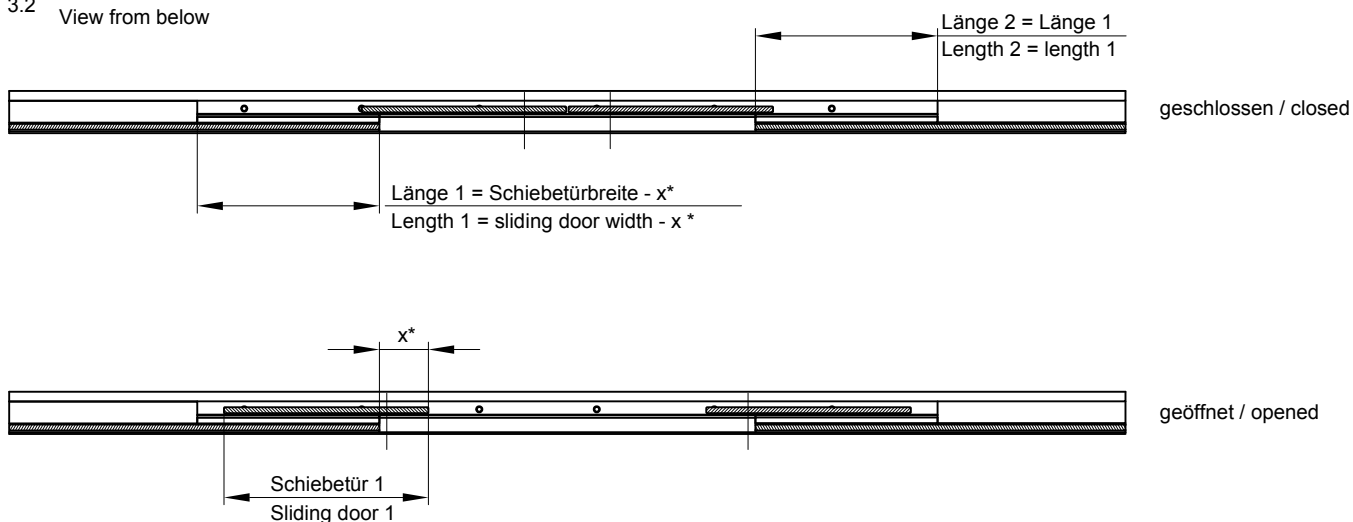

* X ergibt sich aus der Art und Position des Griffes.
* X is a result of form and position of the pull handle.

Variante 3:

Version 3:

3.3 Seitenteil-Einlegeprofil auf die benötigte Länge schneiden!
 3.3 Conform the sidelight inlaid profile to the desired length!



3.3 Sicht von unten
 View from below

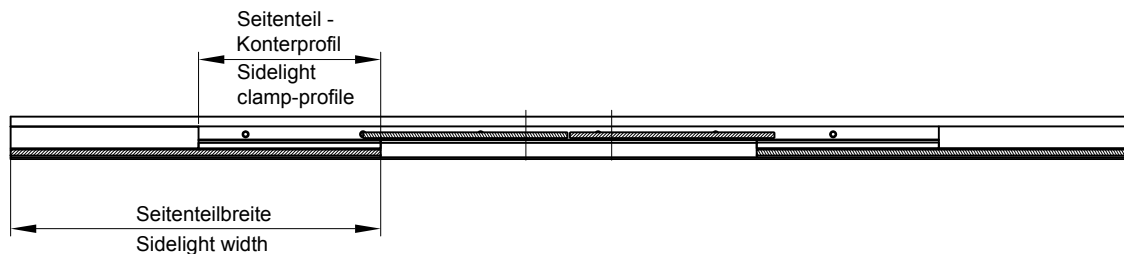

4. Montage des Seitenteil-Einlegeprofils:
4. Installation of sidelight inlaid profile:



Variante 1:

Version 1:

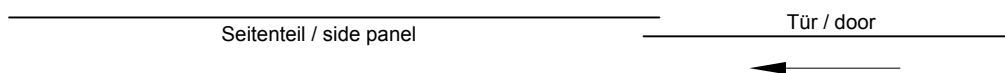
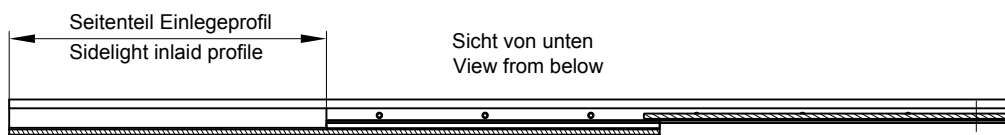

Variante 2:

Version 2:

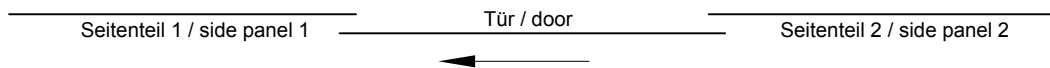
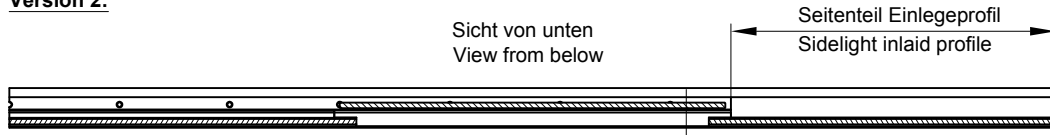

Variante 3:

Version 3:

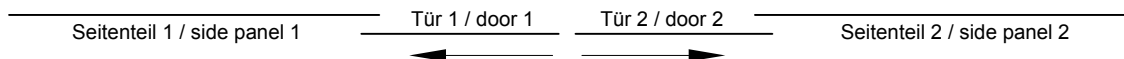
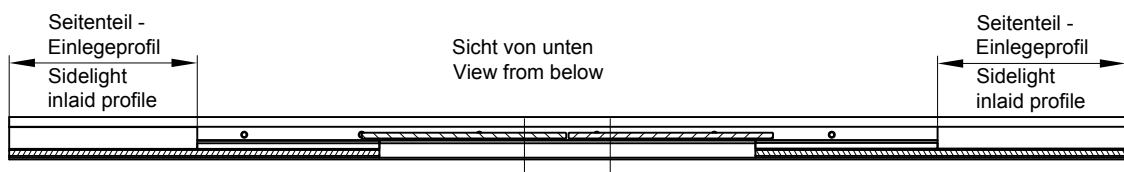

4. Montage des Seitenteil-Einlegeprofils:
4. Installation of sidelight inlaid profile:

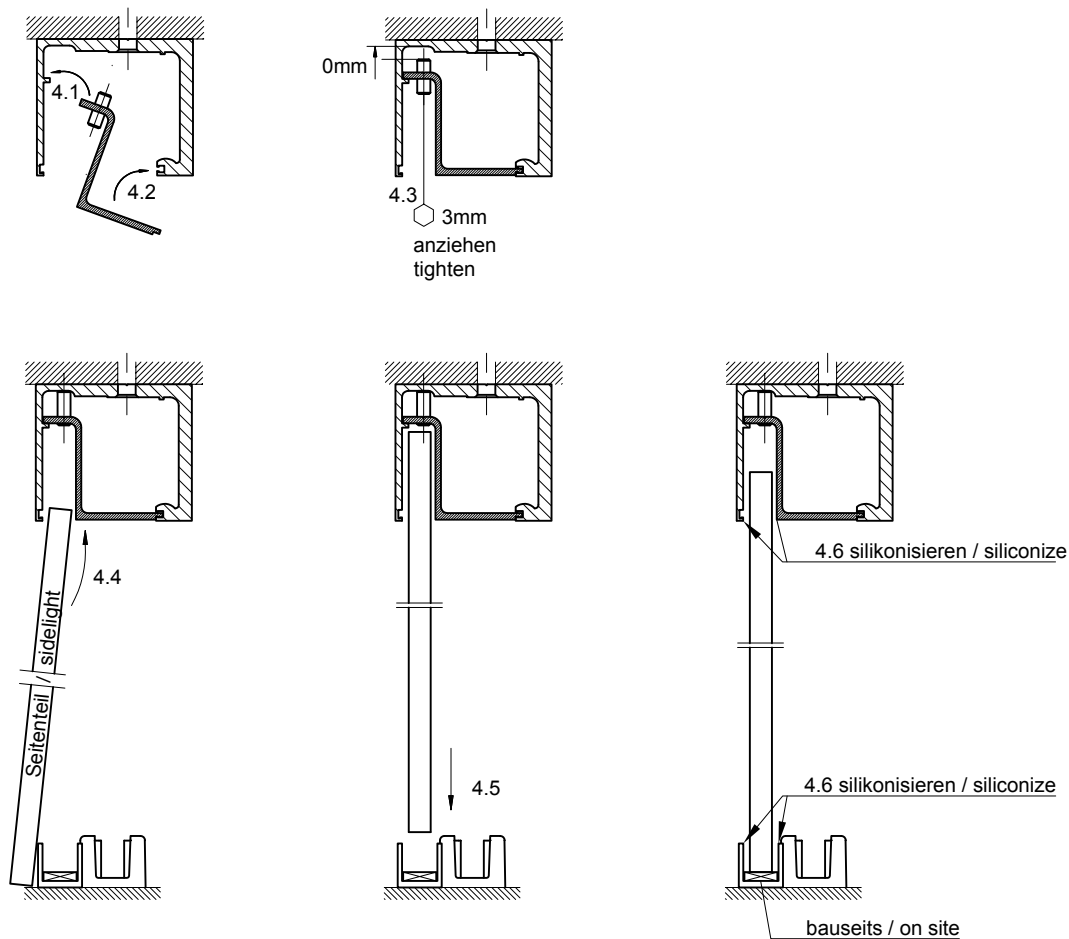

5. Montage des Seitenteil-Konterprofils:
5. Installation of sidelight fixing profile:



Siehe Hauptmontageanleitung AGILE 150!
 See main installation instruction AGILE 150!

6. Montage des Sichtschutzprofils:
6. Installation of view protection profile:



Siehe Hauptmontageanleitung AGILE 150!
 See main installation instruction AGILE 150!